

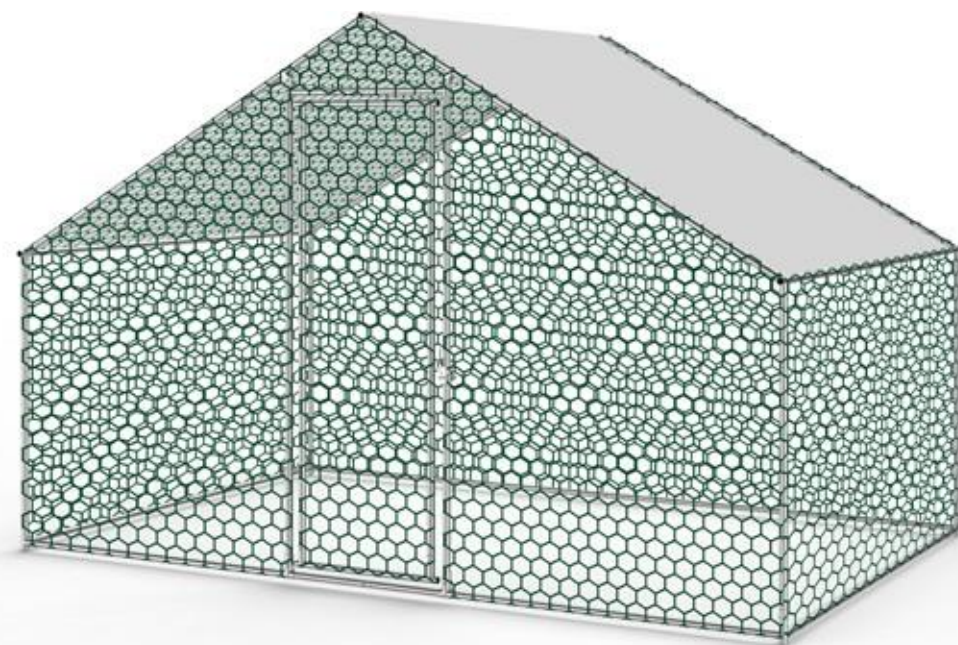





















# ENCLOS

## 3x2x2m

### NOTICE DE MONTAGE



PARTIE	DESCRIPTION	PHOTO	QUANTITE
①	1870mm		5
②	1410mm		4
③	970mm		4
④	1650mm		4
⑤	560mm		2
⑥	660mm		1
D1			1
D2	1470mm		1
D3	1750mm		1
A			4
B			2

PARTIE	DESCRIPTION	PHOTO	QUANTITE
D			6
F			2
G			4
H			4
I			1
J			10
K			4
L			/
M			/
N			24mx1
O			1

# 1.ASSEMBLAGE DE LA BASE

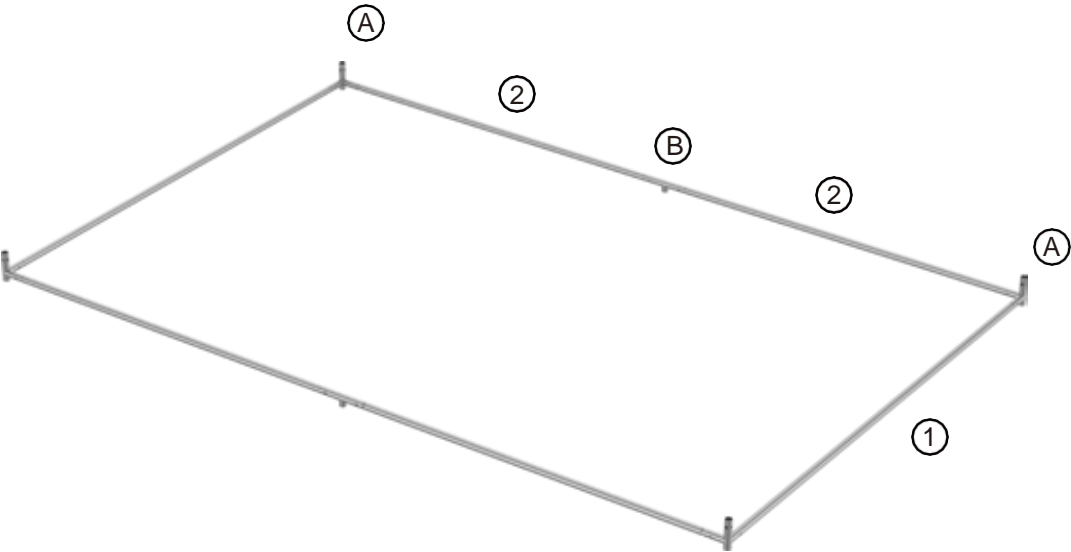

# 2.ASSEMBLAGE DES TUBES VERTICAUX

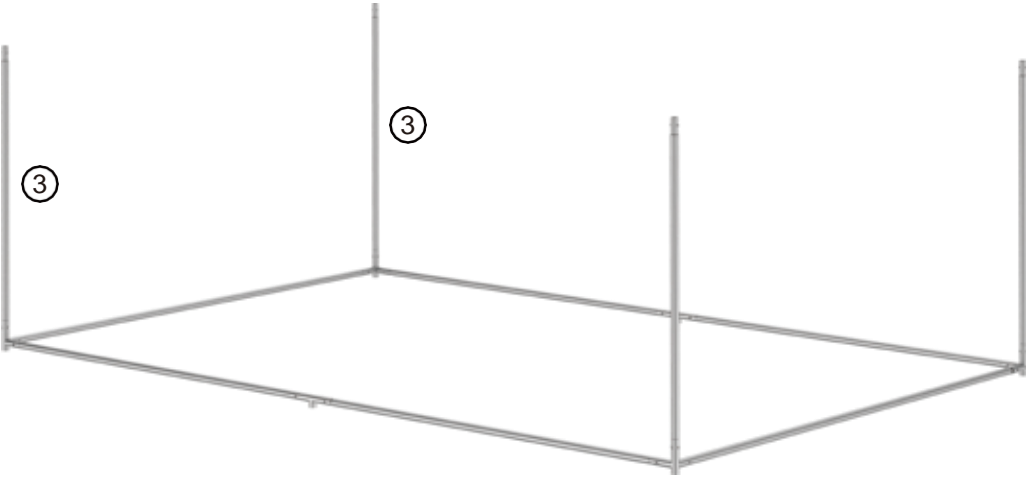
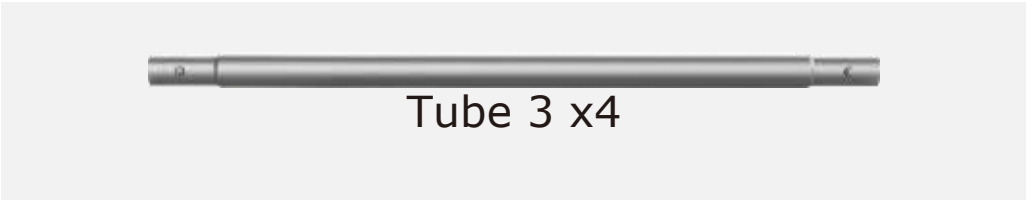

### 3. ASSEMBLAGE DE LA STRUCTURE DU TOIT

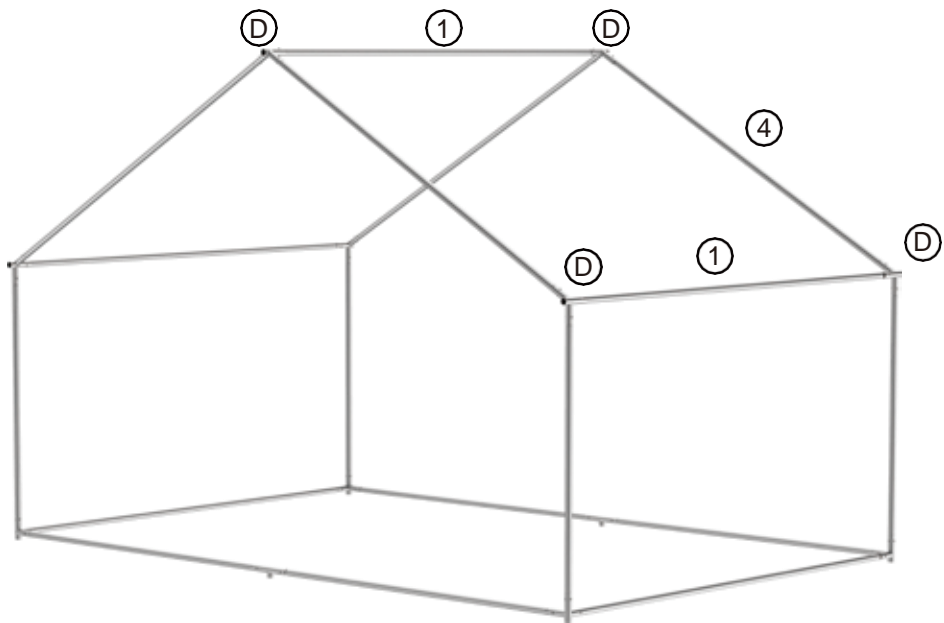
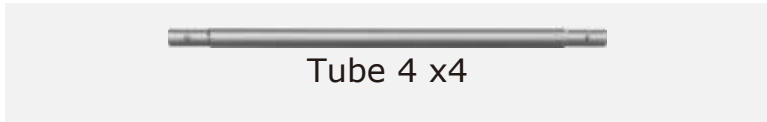
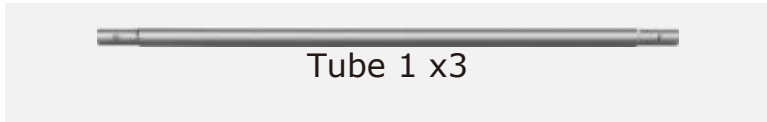

### 4. ASSEMBLAGE DE LA PORTE

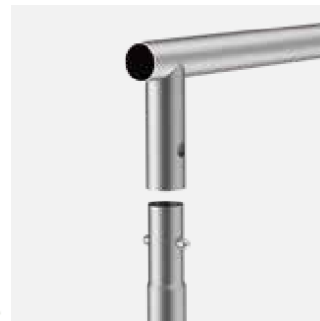
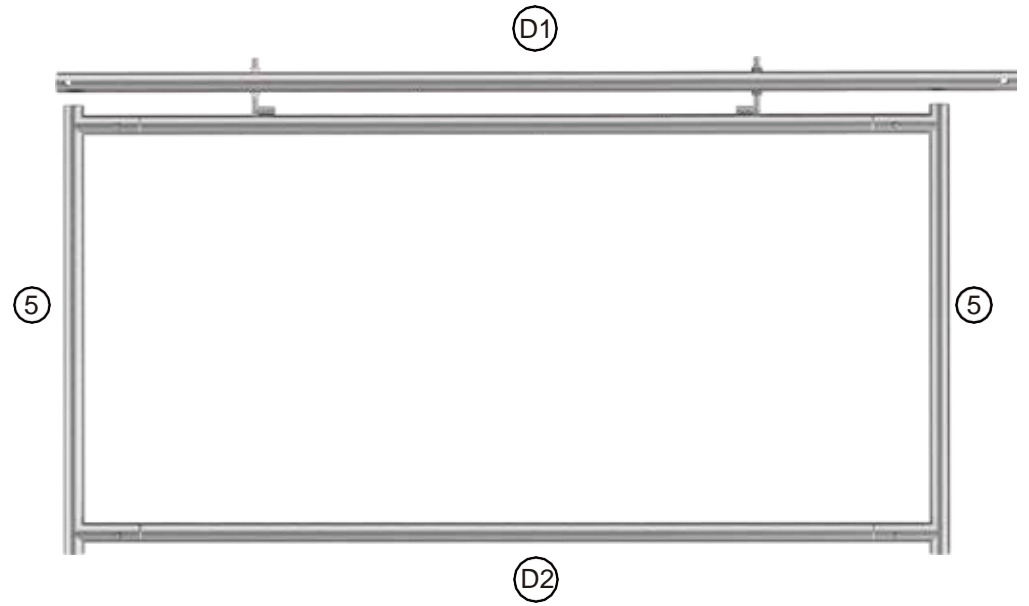
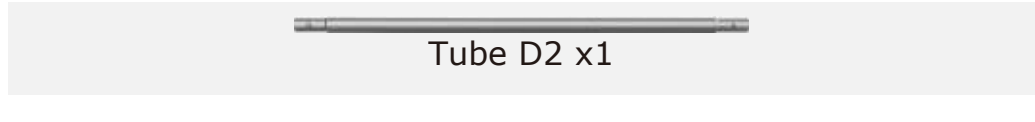
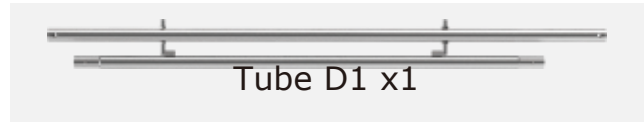
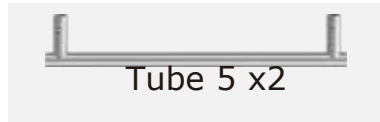

## 5. MISE EN PLACE DE LA PORTE

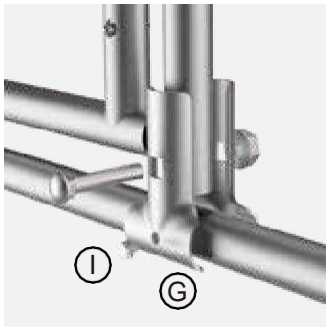
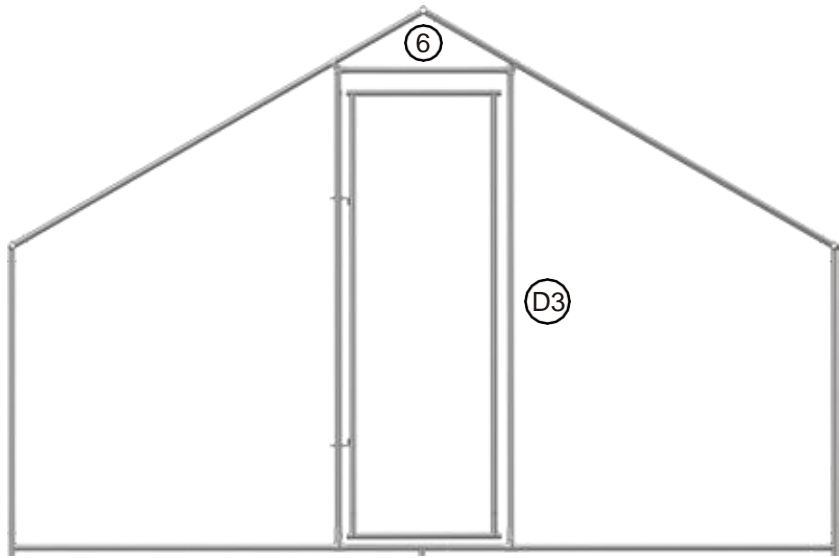

## 7. INSTALLATION DU GRILLAGE

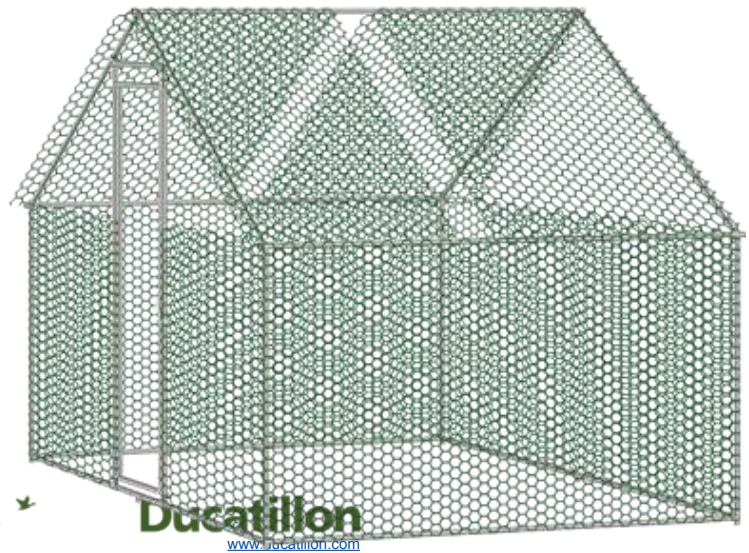
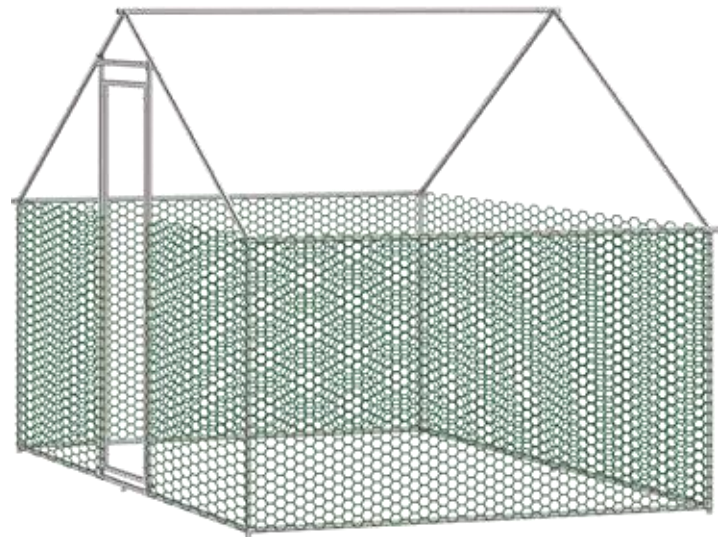

Ducatillon  
[www.ducatillon.com](http://www.ducatillon.com)



## 8. INSTALLATION DU TOIT

